

ISS	REVISIONS
	DESCRIPTION\DATE
A	主體長度原32.7mm改為32mm\04/27/10"
A1	中心對SOLDER HOLE1.0mm改為1.5mm\03/21/12"

RoHS COMPLIANT

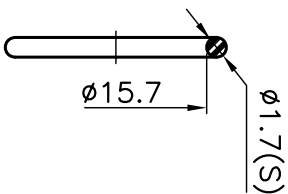

5/8-24UNEF-2A

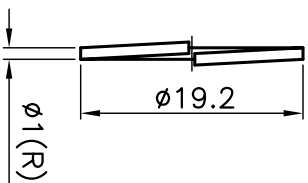
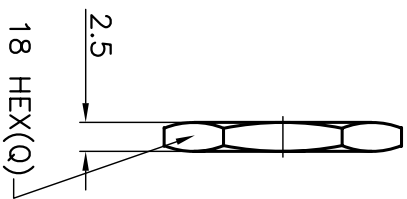
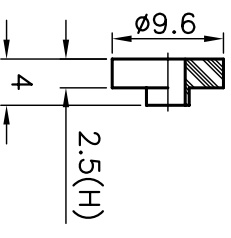
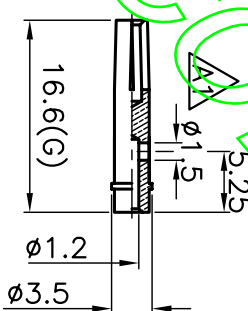
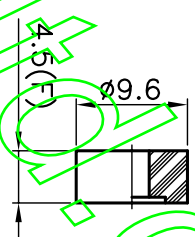
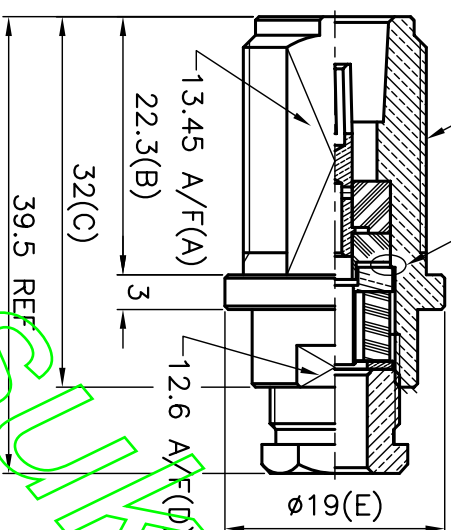

鐵弗龍與主體
相對位置
 $0 \pm 0.8(T)$

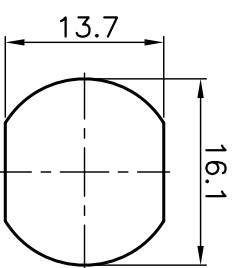
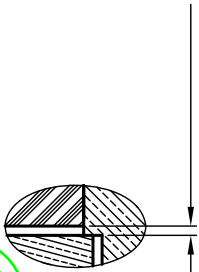

PANEL HOLE

A VIEW

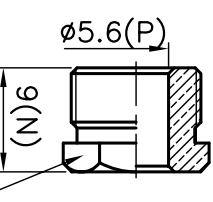
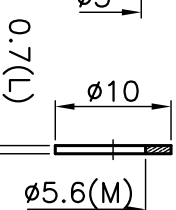
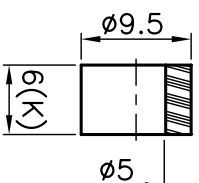
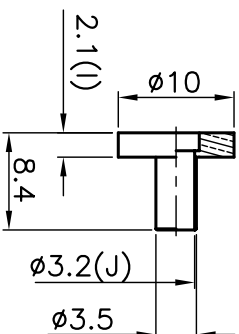
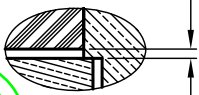

11 HEX(O)

CONNECTORS CABLES
GBS
SPECIALIST LTD.

TITLE: N FEMALE BULKHEAD CLAMP
(FOR RG58, RG223)

PART NO: NBJSC5801

DR. NO:

030

SHEET: .

SCALE: 1.5/1

NO. DESCRIPTION

MATERIAL

FINISH

APRD:
CHKD:
DR:

UNLESS OTHERWISE SPECIFIED TOLERANCES
0.5-6 = ± 0.2
>6-30 = ± 0.4
>30-120 = ± 0.6
>120-315 = ± 1.1
>315-1000 = ± 1.6
ANGLES = $\pm 5^\circ$

NUT	BRASS	NICKEL
LOCK WASHER	STEEL	NICKEL
GASKET	RUBBER	RED
NUT	BRASS	NICKEL
WASHER	BRASS	NICKEL
GASKET	SILICONE	WHITE
TOP HAT	BRASS	NICKEL
INSULATOR	TEFLON	WHITE
CONTACT PIN	PHOSPHOR BRONZE	GOLD
INSULATOR	TEFLON	WHITE
BODY	BRASS	NICKEL
	MATERIAL	FINISH